

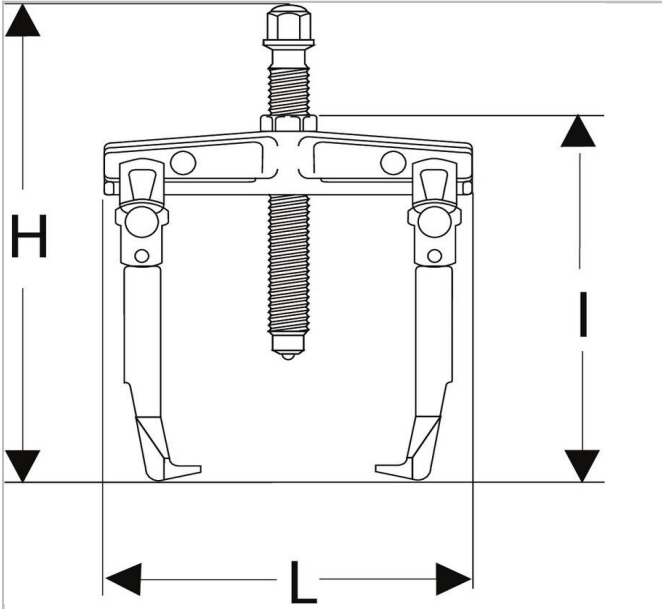

U.302-150 | U.302 - Self-gripping outside pullers with slim legs



Description:

- Comfort: self-gripping legs by return spring. The puller stays in rolling position even when not in tension.
- Adaptable puller accessories: slide hammer U.49AM. - Per tip U.301E1 (U.302 and U.302-150). - Per tip U.301E2 (U.302-200).



	U.302-150
Depth Maxi [mm]	150.0
Length L [mm]	90.0
Height H [mm]	222.0
C Mini - Maxi [mm]	25 - 150
Length [mm]	206.0
Hex Size [mm]	10.0
Screw Size ["]	U.301-04-150
Screw Size Multi [mm]	10.0
Tonnes ["]	1.5
t ["]	15.0
Weight [Kg]	0.9