

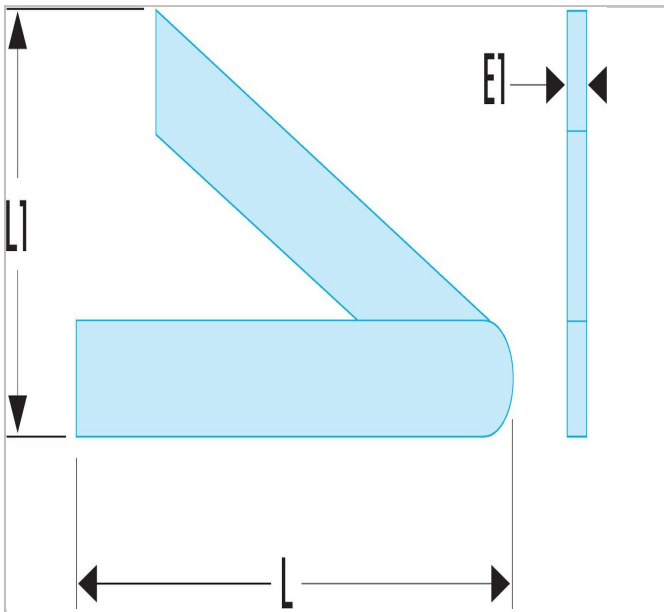

817.20 | 817 - Dummy squares



Description:

- Surface and edges in ground steel.



	817.20
Thickness E1 [mm]	15.0
Weight [g]	491.0
Length L1 [mm]	24 - 195