

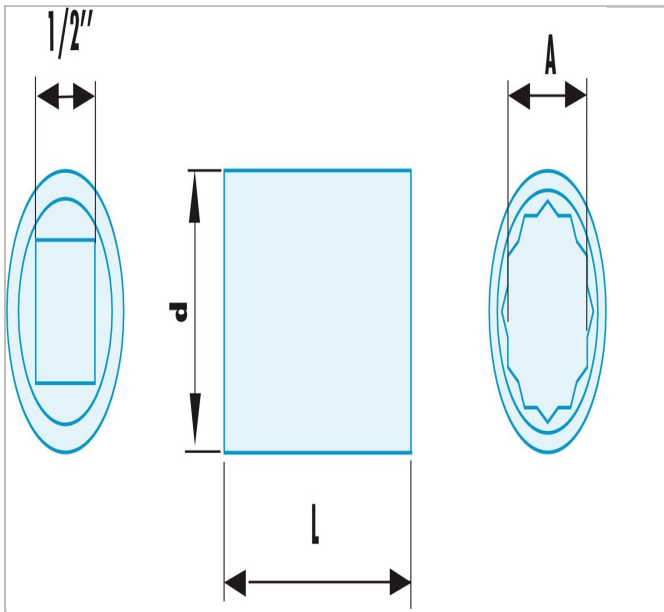

S.16SR | Non sparking 1/2" metric 12-point sockets



Description:

- Special non sparking and anti-magnetic Copper-Beryllium alloy.



 FACOM	S.16SR
A [mm]	16.0
Diameter D Maxi [mm]	25.0
Length L [mm]	40.0
Weight [g]	85.0