

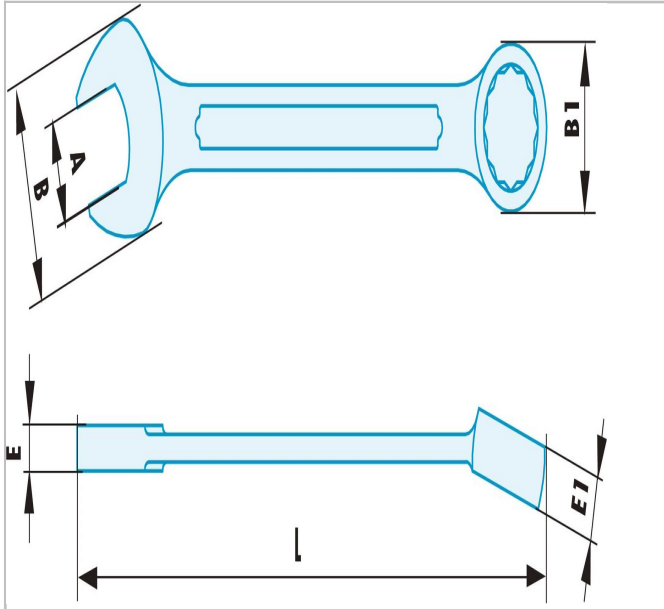

440.25SR | 440.SR - Non sparking metric combination wrenches



Description:

- Special non sparking and anti-magnetic Copper-Beryllium alloy.



	440.25SR
A [mm]	25.0
Length L [mm]	265.0
Thickness E [mm]	9.4
Thickness E1 [mm]	15.2
Head Width B [mm]	49.0
Head Width B1 [mm]	38.0
Weight [g]	260.0