

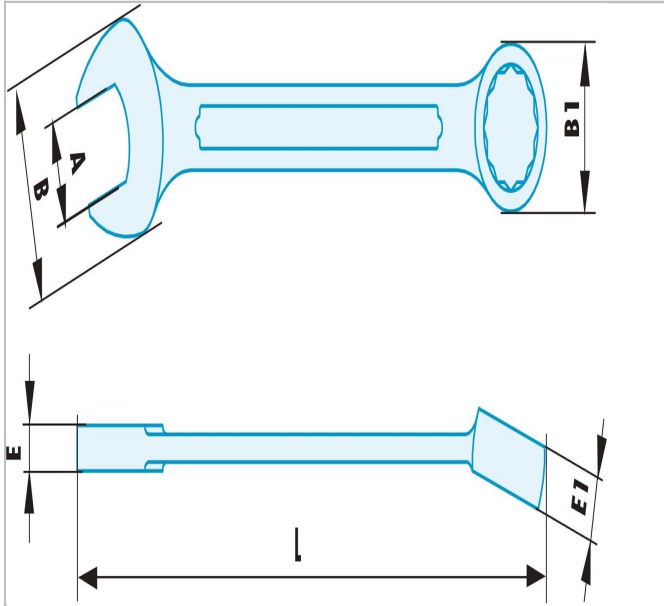

440.34SR | 440.SR - Non sparking metric combination wrenches



Description:

- Special non sparking and anti-magnetic Copper-Beryllium alloy.



	440.34SR
A [mm]	34.0
Length L [mm]	360.0
Thickness E [mm]	15.0
Thickness E1 [mm]	21.0
Head Width B [mm]	72.0
Head Width B1 [mm]	55.0
Weight [g]	850.0