

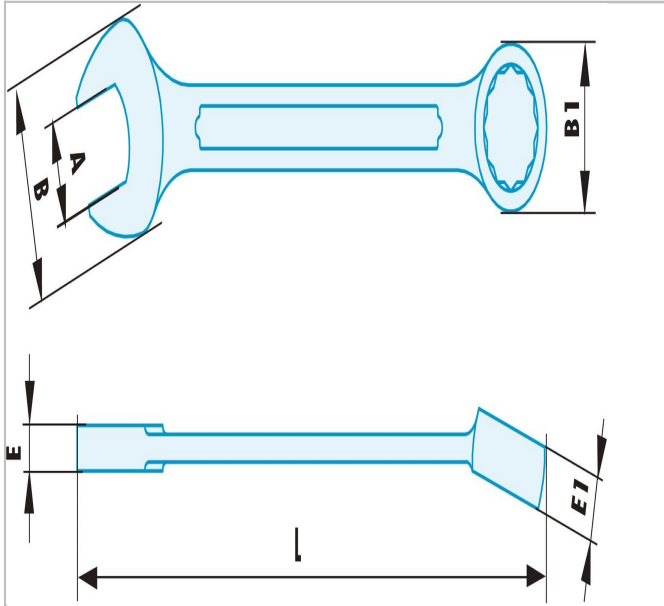

## 440.65SR | 440.SR - Non sparking metric combination wrenches



### Description:

- Special non sparking and anti-magnetic Copper-Beryllium alloy.



	<b>440.65SR</b>
A [mm]	65.0
Length L [mm]	595.0
Thickness E [mm]	21.0
Thickness E1 [mm]	27.0
Head Width B [mm]	125.0
Head Width B1 [mm]	95.0
Weight [g]	3700.0