

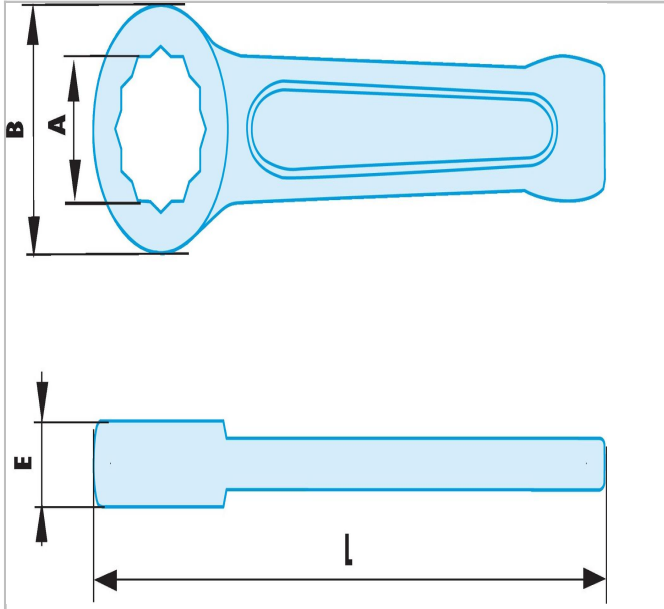

## 50.32SR | 50.SR - Non sparking metric impact ring wrenches



### Description:

- Special non sparking and anti-magnetic Copper-Beryllium alloy.



	50.32SR
A [mm]	32.0
Length L [mm]	185.0
Thickness E [mm]	16.0
Head Width B [mm]	53.0
Weight [g]	465.0