

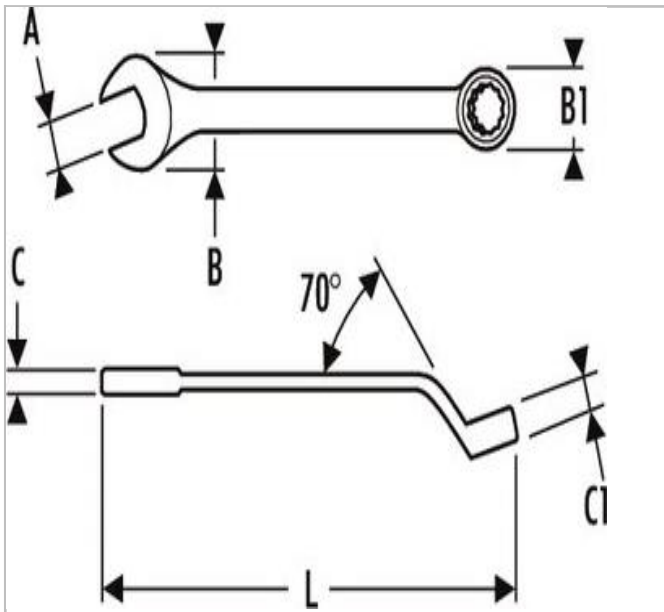

E117395 | EXPERT 6 x 6 point flare nut wrenches



Description:

- DIN 3118
- ISO 691
- 12-point OGV® ring angled at 15°.
- Open end angled at 15° from handle axis.
- 6-point heads up to 12 x 14 mm.
- Forged in Chrome Vanadium steel.
- High chrome finish.



	E117395
A [in]	19
Length L [mm]	228.0
Head Height C [mm]	33.4
Head Height C1 [mm]	38.4
Head Width B [mm]	33.4
Head Width B1 [mm]	38.4
Weight [mm]	0.229
Diameter [mm]	15.0
Diameter D1 [mm]	17.0