

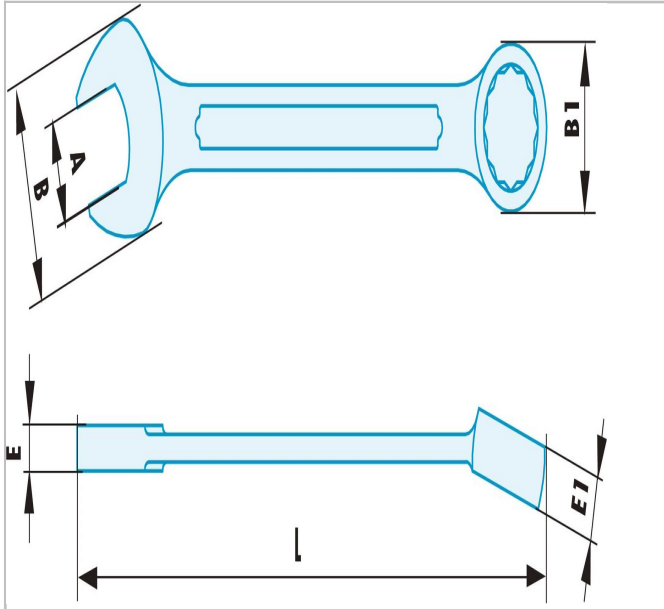

440.22SR | 440.SR - Non sparking metric combination wrenches



Description:

- Special non sparking and anti-magnetic Copper-Beryllium alloy.



	440.22SR
A [mm]	22.0
Length L [mm]	245.0
Thickness E [mm]	9.4
Thickness E1 [mm]	14.0
Head Width B [mm]	46.0
Head Width B1 [mm]	36.0
Weight [g]	250.0