

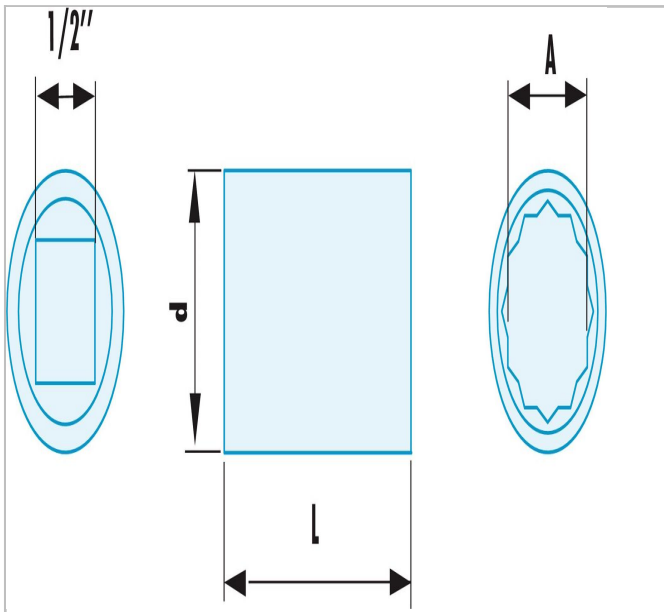

S.10SR | Non sparking 1/2" metric 12-point sockets



Description:

- Special non sparking and anti-magnetic Copper-Beryllium alloy.



 S.10SR	
A [mm]	10.0
Diameter D Maxi [mm]	24.0
Length L [mm]	40.0
Weight [g]	80.0