

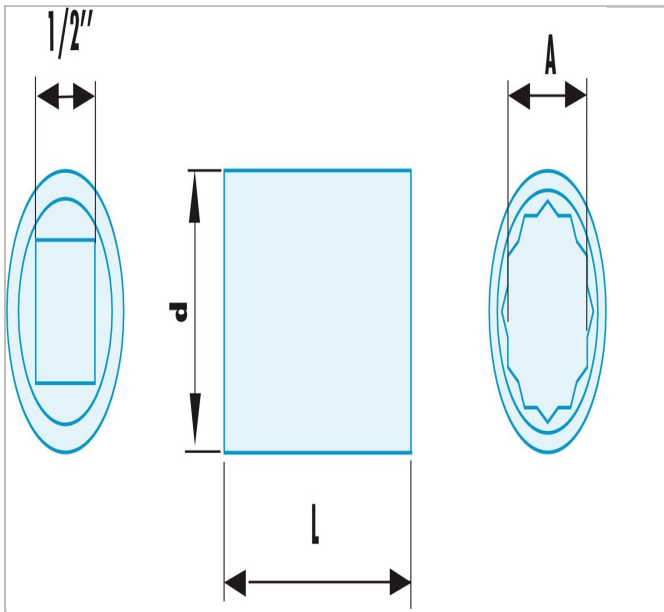

## S.25SR | Non sparking 1/2" metric 12-point sockets



### Description:

- Special non sparking and anti-magnetic Copper-Beryllium alloy.



 S.25SR	
A [mm]	25.0
Diameter D Maxi [mm]	36.0
Length L [mm]	43.0
Weight [g]	200.0