

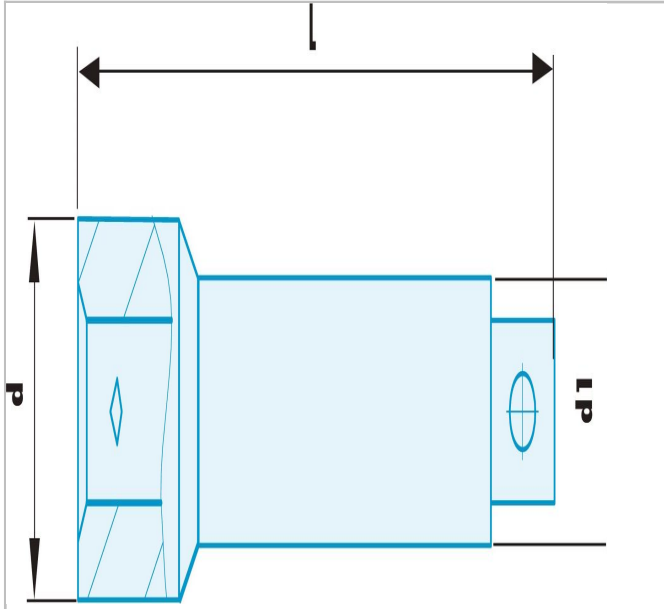

## S.208SR | SKM.SR - Non sparking 1/2" - 3/4" - 1" extensions



### Description:

- Special non sparking and anti-magnetic Copper-Beryllium alloy.



	S.208SR
Diameter [mm]	24.0
Length L [mm]	100.0
Weight [Kg]	0.245
Diameter D1 [mm]	16.5