

## S.206 | S - 1/2" drive extensions





**Standards:**

NF ISO 3316, ISO 3316, DIN 3123, ASME B107.10

**Description:**

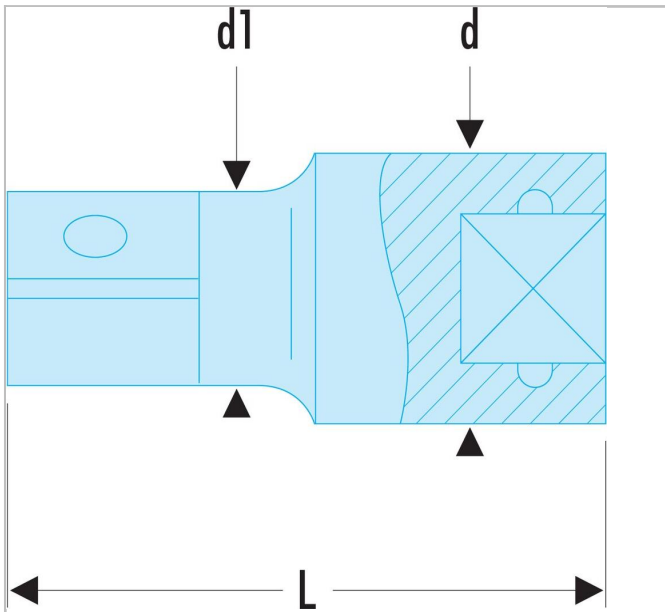
- Finish: bright chrome.



 S.206	
Diameter [mm]	23.0
Diameter D1 [mm]	16.5
Length L [mm]	52.5
Square [in]	1/2
Weight [g]	90.0